

NTD5865NL

N-Channel Power MOSFET 60 V, 46 A, 16 mΩ

Features

- Low Gate Charge
- Fast Switching
- High Current Capability
- 100% Avalanche Tested
- These Devices are Pb-Free, Halogen Free and are RoHS Compliant

MAXIMUM RATINGS (T_J = 25°C unless otherwise noted)

Parameter	Symbol	Value	Unit	
Drain-to-Source Voltage	V _{DSS}	60	V	
Gate-to-Source Voltage – Continuous	V _{GS}	±20	V	
Gate-to-Source Voltage – Non-Repetitive (t _p < 10 μs)	V _{GS}	±30	V	
Continuous Drain Current (R _{θJC})	Steady State	T _C = 25°C	I _D = 46	A
		T _C = 100°C	33	
Power Dissipation (R _{θJC})		T _C = 25°C	P _D = 71	W
Pulsed Drain Current	t _p = 10 μs	I _{DM}	203	A
Operating Junction and Storage Temperature	T _J , T _{stg}	-55 to 175	°C	
Source Current (Body Diode)	I _S	46	A	
Single Pulse Drain-to-Source Avalanche Energy	(L = 0.1 mH)	E _{AS}	36	mJ
		I _{AS}	27	A
Lead Temperature for Soldering Purposes (1/8" from case for 10 s)	T _L	260	°C	

Stresses exceeding those listed in the Maximum Ratings table may damage the device. If any of these limits are exceeded, device functionality should not be assumed, damage may occur and reliability may be affected.

THERMAL RESISTANCE MAXIMUM RATINGS

Parameter	Symbol	Value	Unit
Junction-to-Case (Drain)	R _{θJC}	2.1	°C/W
Junction-to-Ambient – Steady State (Note 1)	R _{θJA}	49	

1. Surface-mounted on FR4 board using a 650 mm², 2 oz. Cu pad.



ON Semiconductor®

<http://onsemi.com>

V _{(BR)DSS}	R _{DS(on)} MAX	I _D MAX
60 V	16 mΩ @ 10 V	46 A
	19 mΩ @ 4.5 V	

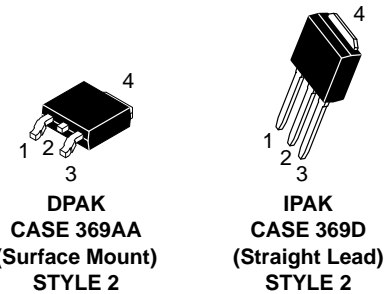
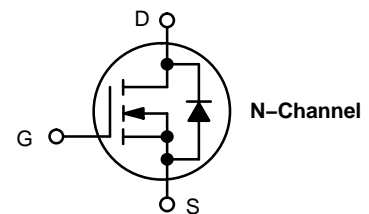

MARKING DIAGRAMS & PIN ASSIGNMENT

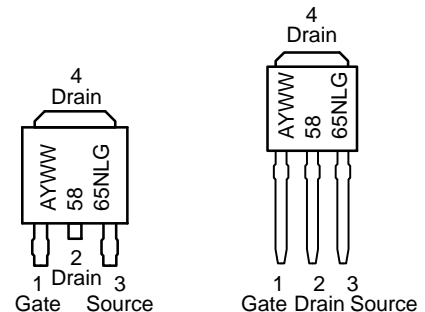

- A = Assembly Location*
- Y = Year
- WW = Work Week
- 5865NL = Device Code
- G = Pb-Free Package

* The Assembly Location code (A) is front side optional. In cases where the Assembly Location is stamped in the package, the front side assembly code may be blank.

ORDERING INFORMATION

See detailed ordering and shipping information on page 5 of this data sheet.

NTD5865NL

ELECTRICAL CHARACTERISTICS (T_J = 25°C unless otherwise noted)

Parameter	Symbol	Test Condition	Min	Typ	Max	Unit
OFF CHARACTERISTICS						
Drain-to-Source Breakdown Voltage	V _{(BR)DSS}	V _{GS} = 0 V, I _D = 250 μA	60			V
Drain-to-Source Breakdown Voltage Temperature Coefficient	V _{(BR)DSS} /T _J			55		mV/°C
Zero Gate Voltage Drain Current	I _{DSS}	V _{GS} = 0 V, V _{DS} = 60 V	T _J = 25°C		1.0	μA
			T _J = 150°C		100	
Gate-to-Source Leakage Current	I _{GSS}	V _{DS} = 0 V, V _{GS} = ±20 V			±100	nA

ON CHARACTERISTICS (Note 2)

Gate Threshold Voltage	V _{GS(TH)}	V _{GS} = V _{DS} , I _D = 250 μA	1.0		2.0	V
Negative Threshold Temperature Coefficient	V _{GS(TH)} /T _J			5.6		mV/°C
Drain-to-Source on Resistance	R _{DS(on)}	V _{GS} = 10 V, I _D = 20 A		13	16	mΩ
Drain-to-Source on Resistance	R _{DS(on)}	V _{GS} = 4.5 V, I _D = 20 A		16	19	mΩ
Forward Transconductance	g _{FS}	V _{DS} = 15 V, I _D = 20 A		15		S

CHARGES, CAPACITANCES AND GATE RESISTANCES

Input Capacitance	C _{iss}	V _{GS} = 0 V, f = 1.0 MHz, V _{DS} = 25 V		1400		pF
Output Capacitance	C _{oss}			137		
Reverse Transfer Capacitance	C _{riss}			95		
Total Gate Charge	Q _{G(TOT)}	V _{GS} = 10 V, V _{DS} = 48 V, I _D = 40 A		29		nC
Threshold Gate Charge	Q _{G(TH)}			1.1		
Gate-to-Source Charge	Q _{GS}			4		
Gate-to-Drain Charge	Q _{GD}			8		
Total Gate Charge	Q _{G(TOT)}	V _{GS} = 4.5 V, V _{DS} = 48 V, I _D = 40 A		15		nC
Gate Resistance	R _G			1.3		Ω

SWITCHING CHARACTERISTICS (Note 3)

Turn-On Delay Time	t _{d(on)}	V _{GS} = 10 V, V _{DD} = 48 V, I _D = 40 A, R _G = 2.5 Ω		8.4		ns
Rise Time	t _r			12.4		
Turn-Off Delay Time	t _{d(off)}			26		
Fall Time	t _f			4.4		

DRAIN-SOURCE DIODE CHARACTERISTICS

Forward Diode Voltage	V _{SD}	V _{GS} = 0 V, I _S = 40 A	T _J = 25°C		0.95	1.2	V
			T _J = 125°C		0.85		
Reverse Recovery Time	t _{RR}	V _{GS} = 0 V, dI _S /dt = 100 A/μs, I _S = 40 A		20		ns	
Charge Time	t _a			13			
Discharge Time	t _b			7			
Reverse Recovery Charge	Q _{RR}			13			nC

Product parametric performance is indicated in the Electrical Characteristics for the listed test conditions, unless otherwise noted. Product performance may not be indicated by the Electrical Characteristics if operated under different conditions.

2. Pulse Test: Pulse Width ≤ 300 μs, Duty Cycle ≤ 2%.
3. Switching characteristics are independent of operating junction temperatures.

TYPICAL CHARACTERISTICS

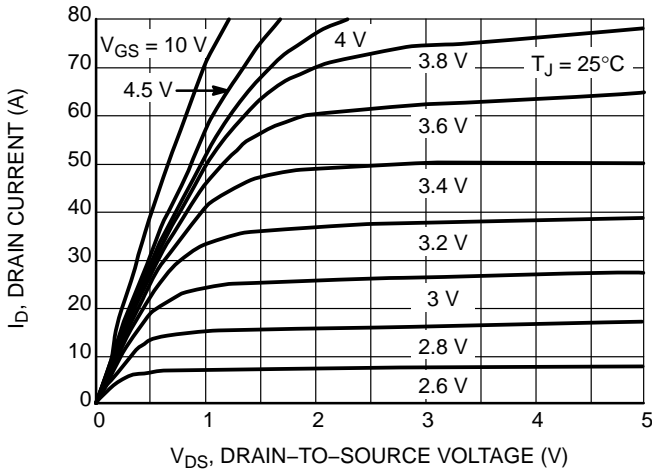

Figure 1. On-Region Characteristics

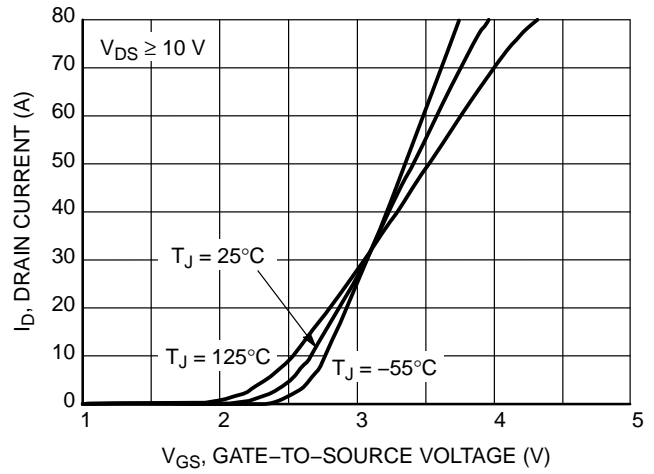

Figure 2. Transfer Characteristics

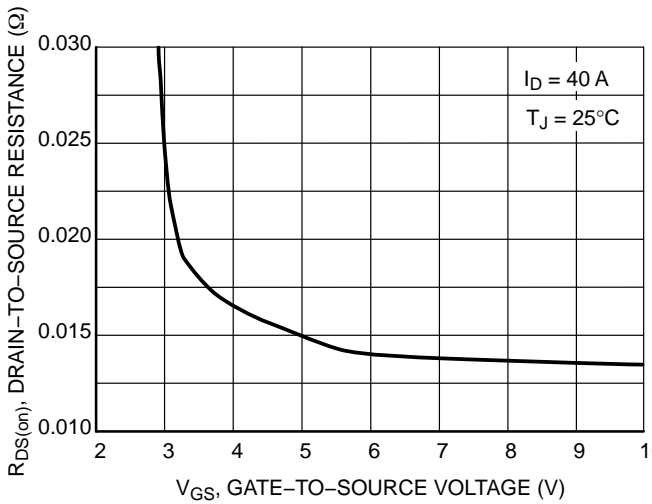

Figure 3. On-Resistance vs. Gate Voltage

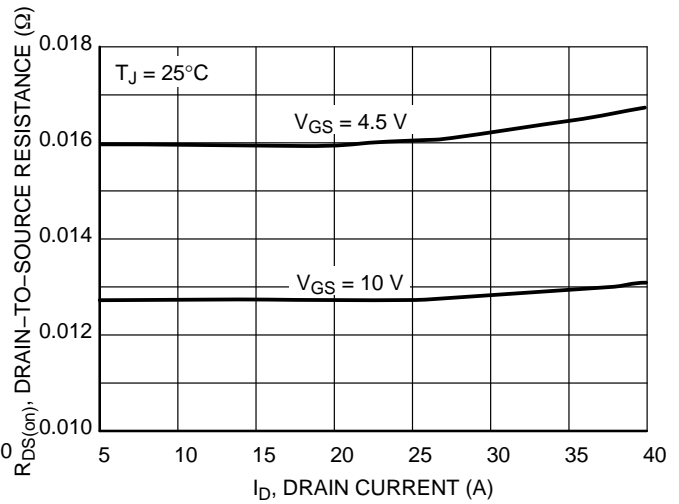

Figure 4. On-Resistance vs. Drain Current

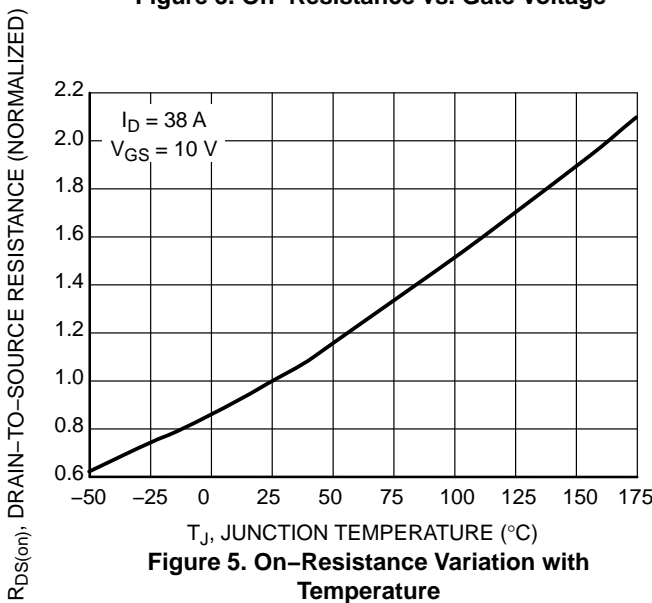

Figure 5. On-Resistance Variation with Temperature

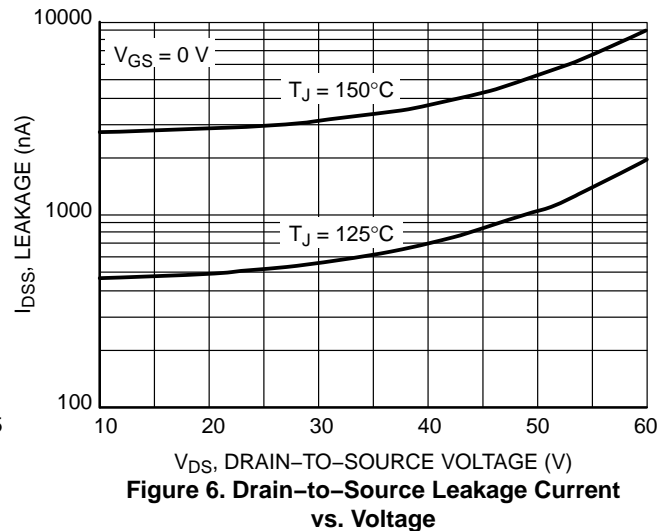

Figure 6. Drain-to-Source Leakage Current vs. Voltage

NTD5865NL

TYPICAL CHARACTERISTICS

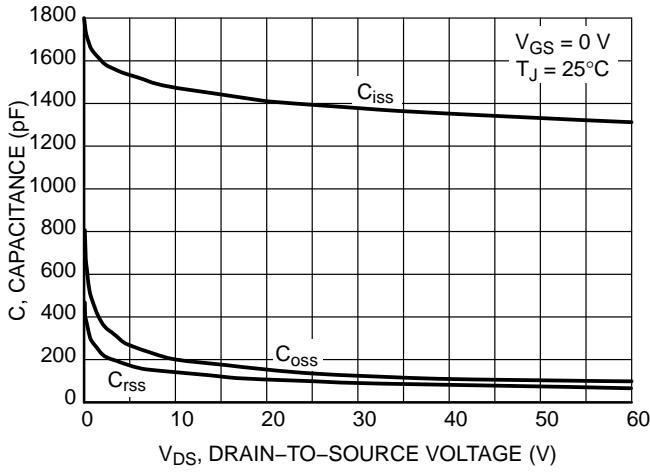

Figure 7. Capacitance Variation

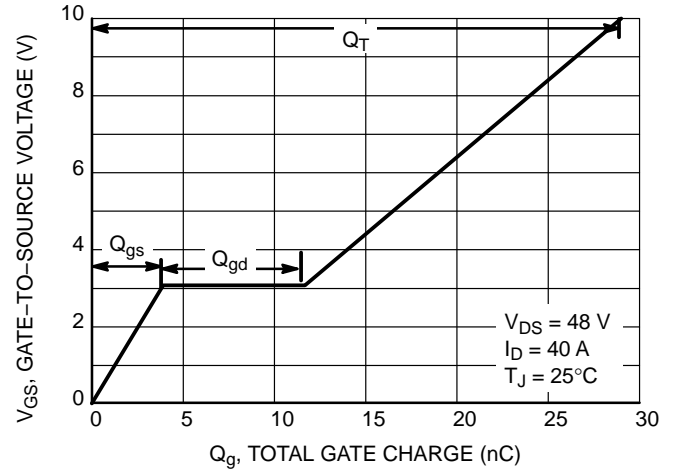

Figure 8. Gate-to-Source vs. Total Charge

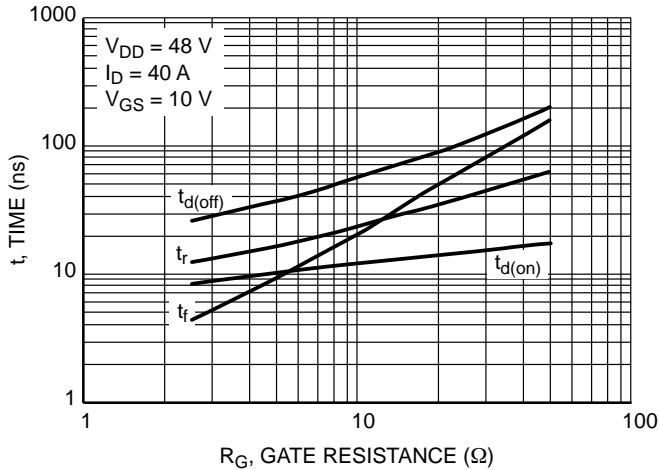

Figure 9. Resistive Switching Time Variation vs. Gate Resistance

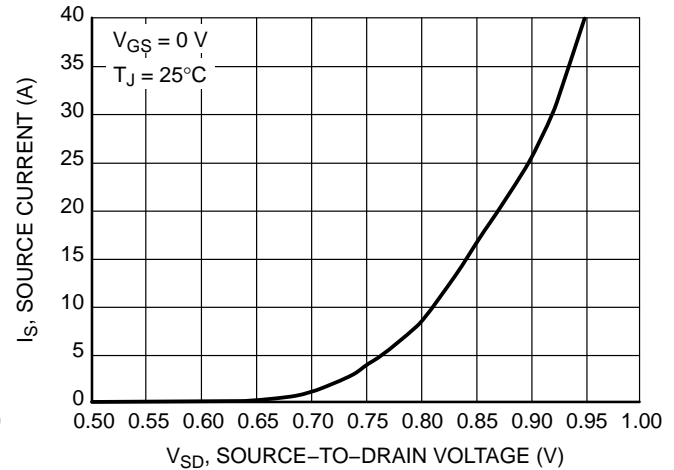

Figure 10. Diode Forward Voltage vs. Current

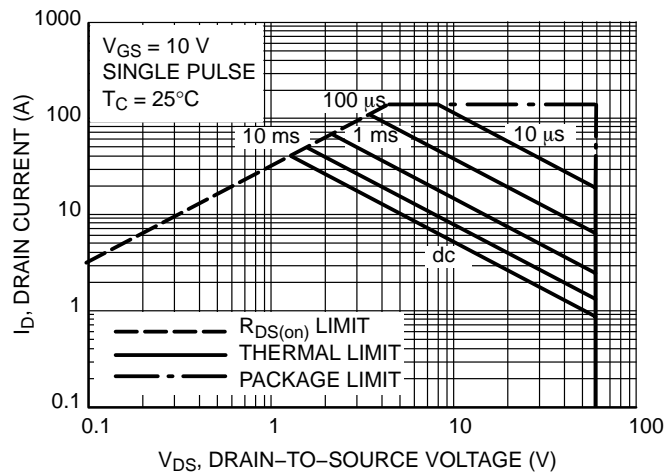

Figure 11. Maximum Rated Forward Biased Safe Operating Area

NTD5865NL

TYPICAL CHARACTERISTICS

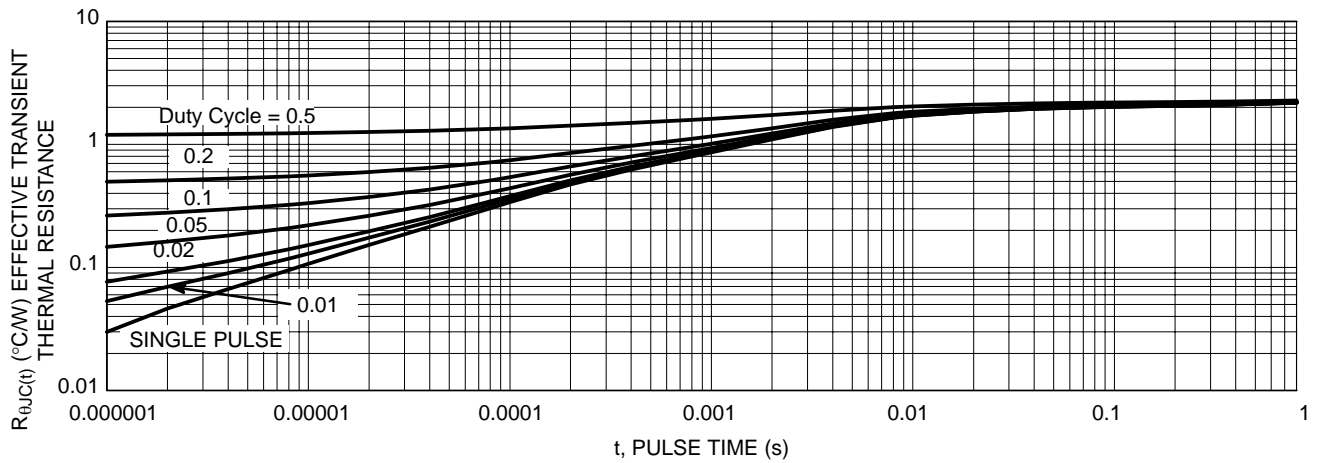

Figure 12. Thermal Response

ORDERING INFORMATION

Order Number	Package	Shipping [†]
NTD5865NL-1G	IPAK (Straight Lead) (Pb-Free)	75 Units / Rail
NTD5865NLT4G	DPAK (Pb-Free)	2500 / Tape & Reel

[†]For information on tape and reel specifications, including part orientation and tape sizes, please refer to our Tape and Reel Packaging Specifications Brochure, BRD8011/D.

NTD5865NL

PACKAGE DIMENSIONS

DPAK (SINGLE GUAGE) CASE 369AA ISSUE B

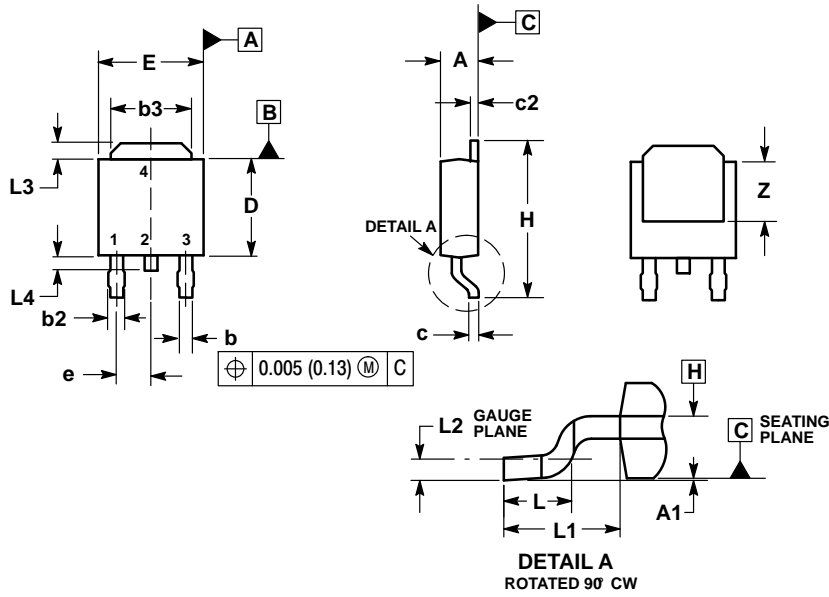

NOTES:

1. DIMENSIONING AND TOLERANCING PER ASME Y14.5M, 1994.
2. CONTROLLING DIMENSION: INCHES.
3. THERMAL PAD CONTOUR OPTIONAL WITHIN DIMENSIONS b3, L3 and Z.
4. DIMENSIONS D AND E DO NOT INCLUDE MOLD FLASH, PROTRUSIONS, OR BURRS. MOLD FLASH, PROTRUSIONS, OR GATE BURRS SHALL NOT EXCEED 0.006 INCHES PER SIDE.
5. DIMENSIONS D AND E ARE DETERMINED AT THE OUTERMOST EXTREMES OF THE PLASTIC BODY.
6. DATUMS A AND B ARE DETERMINED AT DATUM PLANE H.

DIM	INCHES		MILLIMETERS	
	MIN	MAX	MIN	MAX
A	0.086	0.094	2.18	2.38
A1	0.000	0.005	0.00	0.13
b	0.025	0.035	0.63	0.89
b2	0.030	0.045	0.76	1.14
b3	0.180	0.215	4.57	5.46
c	0.018	0.024	0.46	0.61
c2	0.018	0.024	0.46	0.61
D	0.235	0.245	5.97	6.22
E	0.250	0.265	6.35	6.73
e	0.090 BSC		2.29 BSC	
H	0.370	0.410	9.40	10.41
L	0.055	0.070	1.40	1.78
L1	0.108 REF		2.74 REF	
L2	0.020 BSC		0.51 BSC	
L3	0.035	0.050	0.89	1.27
L4	---	0.040	---	1.01
Z	0.155	---	3.93	---

SOLDERING FOOTPRINT*

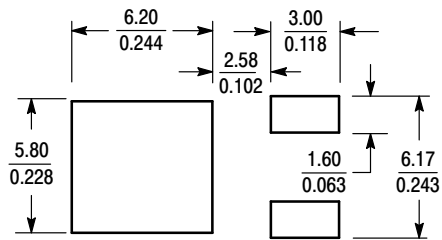

SCALE 3:1 $\left(\frac{\text{mm}}{\text{inches}}\right)$

STYLE 2:

- PIN 1. GATE
2. DRAIN
3. SOURCE
4. DRAIN

*For additional information on our Pb-Free strategy and soldering details, please download the ON Semiconductor Soldering and Mounting Techniques Reference Manual, SOLDERRM/D.

NTD5865NL

PACKAGE DIMENSIONS

IPAK CASE 369D ISSUE C

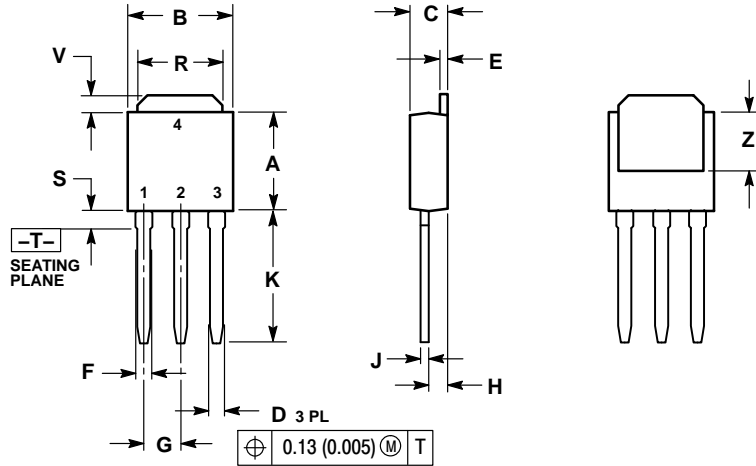

NOTES:

1. DIMENSIONING AND TOLERANCING PER ANSI Y14.5M, 1982.
2. CONTROLLING DIMENSION: INCH.

DIM	INCHES		MILLIMETERS	
	MIN	MAX	MIN	MAX
A	0.235	0.245	5.97	6.35
B	0.250	0.265	6.35	6.73
C	0.086	0.094	2.19	2.38
D	0.027	0.035	0.69	0.88
E	0.018	0.023	0.46	0.58
F	0.037	0.045	0.94	1.14
G	0.090 BSC		2.29 BSC	
H	0.034	0.040	0.87	1.01
J	0.018	0.023	0.46	0.58
K	0.350	0.380	8.89	9.65
R	0.180	0.215	4.45	5.45
S	0.025	0.040	0.63	1.01
V	0.035	0.050	0.89	1.27
Z	0.155	---	3.93	---

STYLE 2:

1. GATE
2. DRAIN
3. SOURCE
4. DRAIN

ON Semiconductor and the  are registered trademarks of Semiconductor Components Industries, LLC (SCILLC) or its subsidiaries in the United States and/or other countries. SCILLC owns the rights to a number of patents, trademarks, copyrights, trade secrets, and other intellectual property. A listing of SCILLC's product/patent coverage may be accessed at www.onsemi.com/site/pdf/Patent-Marking.pdf. SCILLC reserves the right to make changes without further notice to any products herein. SCILLC makes no warranty, representation or guarantee regarding the suitability of its products for any particular purpose, nor does SCILLC assume any liability arising out of the application or use of any product or circuit, and specifically disclaims any and all liability, including without limitation special, consequential or incidental damages. "Typical" parameters which may be provided in SCILLC data sheets and/or specifications can and do vary in different applications and actual performance may vary over time. All operating parameters, including "Typicals" must be validated for each customer application by customer's technical experts. SCILLC does not convey any license under its patent rights nor the rights of others. SCILLC products are not designed, intended, or authorized for use as components in systems intended for surgical implant into the body, or other applications intended to support or sustain life, or for any other application in which the failure of the SCILLC product could create a situation where personal injury or death may occur. Should Buyer purchase or use SCILLC products for any such unintended or unauthorized application, Buyer shall indemnify and hold SCILLC and its officers, employees, subsidiaries, affiliates, and distributors harmless against all claims, costs, damages, and expenses, and reasonable attorney fees arising out of, directly or indirectly, any claim of personal injury or death associated with such unintended or unauthorized use, even if such claim alleges that SCILLC was negligent regarding the design or manufacture of the part. SCILLC is an Equal Opportunity/Affirmative Action Employer. This literature is subject to all applicable copyright laws and is not for resale in any manner.

PUBLICATION ORDERING INFORMATION

LITERATURE FULFILLMENT:

Literature Distribution Center for ON Semiconductor
P.O. Box 5163, Denver, Colorado 80217 USA
Phone: 303-675-2175 or 800-344-3860 Toll Free USA/Canada
Fax: 303-675-2176 or 800-344-3867 Toll Free USA/Canada
Email: orderlit@onsemi.com

N. American Technical Support: 800-282-9855 Toll Free
USA/Canada
Europe, Middle East and Africa Technical Support:
Phone: 421 33 790 2910
Japan Customer Focus Center
Phone: 81-3-5817-1050

ON Semiconductor Website: www.onsemi.com

Order Literature: <http://www.onsemi.com/orderlit>

For additional information, please contact your local Sales Representative